

Astral Elite Connect



Inhoud presentatie



- Producten (2 verschillende producten voor privé zwembaden).
- Voordelen en eigenschappen
- Bediening op afstand
- Installatie en configuratie



Producten



- Zout elektrolyse systeem: **Elite Connect** (5-6 g zout/ltr)
 - 4 modellen – 50m³ tot 200m³
- Hydrolyse / elektrolyse: **Elite Connect LS** (1-2g zout/ltr)
 - 2 modellen – 50m³ tot 100m³

Producten



- Hydrolyse / elektrolyse: **Elite Connect LS** (1-2g zout/ltr)

Zeer populaire desinfectie methode

Zowel zwembad als zwembijvers/biopools

Werking: sterke desinfecterende stoffen worden aangemaakt door water te splitsen in O en H atomen.

- Net zo krachtig of krachtiger als chloor
- Geen negatieve bijproducten (chloramine)
 - reactie organische stof → water
- Zwembaden: zoutgehalte van 1,5 – 2 g/l → kleine hoeveelheid vrije chloor
- Zwembijvers: zoutgehalte max 1g/l → chloor niet gewenst

OXIDATION REDUCTION POTENTIAL		
Chemisch product	Symbol	ORP
Radicale Hydroxide	$\cdot\text{OH}$	2,05
Atomaire zuurstof	O	1,78
Ozon	O ₃	1,52
Waterstof Peroxide	H ₂ O ₂	1,30
Hypochloorzuur	H ₂ Cl	1,10
Chloor gas	Cl	1,00
Zuurstof	O ₂	0,94
Natriumhypochloriet	NaCl ₂	0,69

Producten



- Hydrolyse / elektrolyse



Producteigenschaften



Description		12 12LS	24 24LS	32	42
Voltage V_{ac}		230 V - 50-60 Hz.			
Consumption A_{ac}		0.36	0.72	0.89	0.89
Fuse 5x20 mm		2AT	3.15AT	4AT	4AT
Output A_{dc}		2 x 6A	2 x 12A	2 x 16A	7 x 6A
Production g/h		10 ... 12	20 ... 24	25 ... 32	32 ... 42
Pool m^3	16...24°C	60	100	160	200
	+25°C	50	80	120	160
Salinity g/l		Range: 5 ... 12 5 ... 6 (recommended) LS: 2 ... 3 (1 ... 4)			
Housing		ABS			
Control		0 ... 100% (10 levels)			
Inv. polarity		2 h. 3 h. 4 h. TEST			

Producteigenschaften

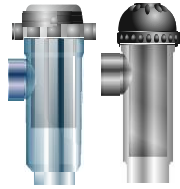

CELL

Description	12 12LS	24 24LS	32	42
Electrodes	PREMIUM grade: 10.000 – 12.000 h.			
Min flow m ³ /h	2	4	6	8
Number	5 (7 LS)	7 (9 LS)	7	13
Material	Derivative methacrylate			
Connection	Gluing PVC Ø 63 mm.			
Pressure max.	1 Kg./cm ²			
Temperature	15 ... 40°C			

Producteigenschaften



AFMETINGEN

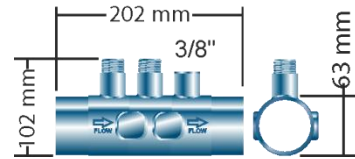
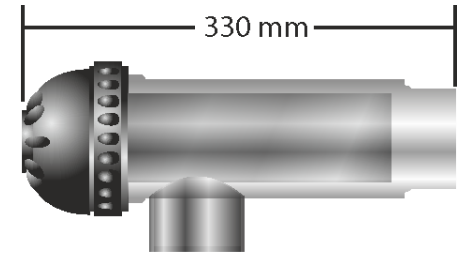
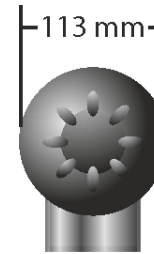
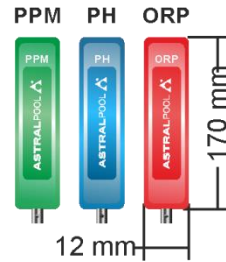

60.100.160

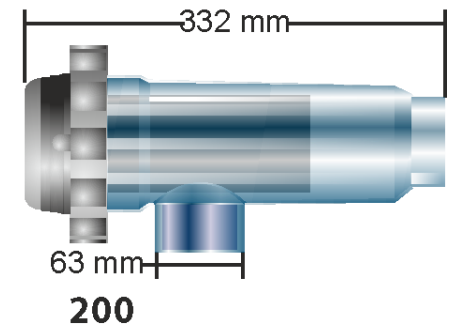
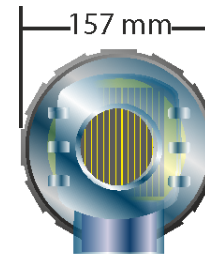
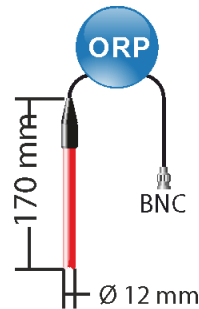
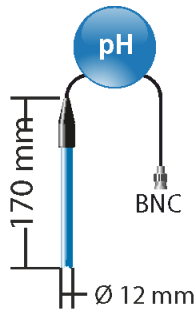
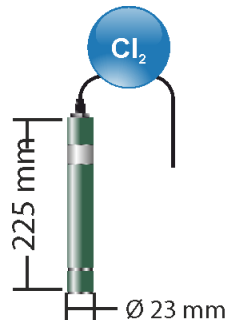

200

Astralpool Elite Connect



- Full color touchscreen

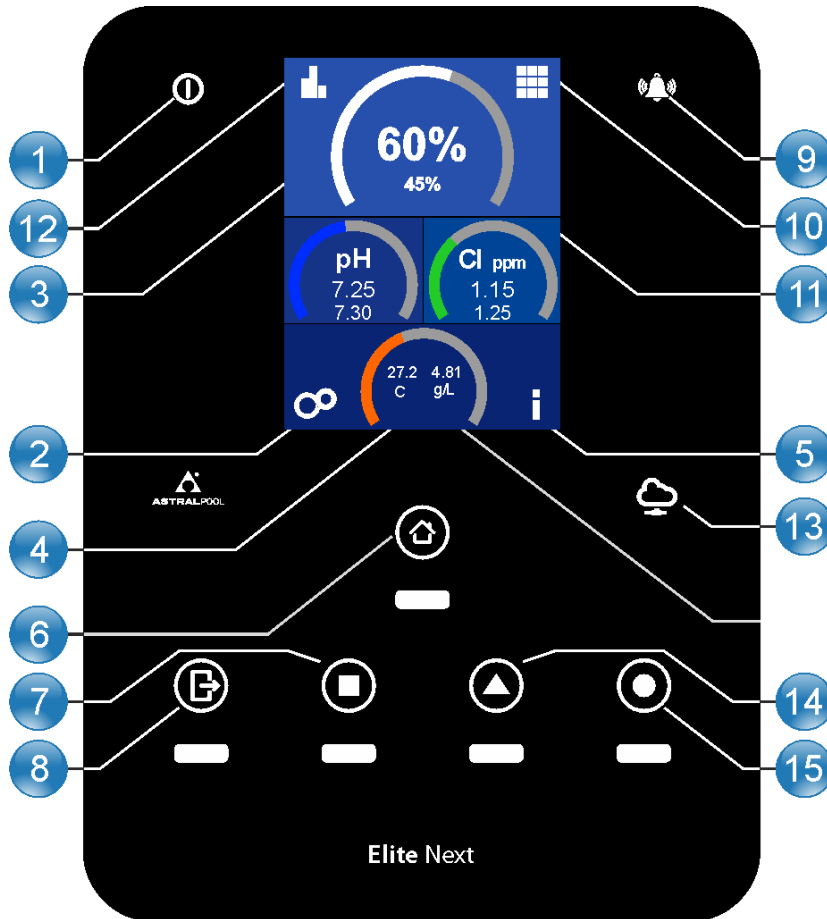

Version	Date	Time	Language
Bright	Volumen	BAUD	PARITY
ADDRESS	%	set	Voltage
Current	Int	Ext	gr/d
% Cover	Inversi	grCl/d	Ala Ele
pH	set	Mode	% Pump
PSTOP	HYS	Intelli	TANK
Ala pH			
		ppm	set
		% Pump	PSTOP HYS
		Intelli	TANK Ala UV
		Hours	IGNITIO TEMP
		gr/L	Gas Flo
		Switch	Ala Sen

FRIDAY
2 MAY

R1 OFF P2 → ☀

R2 ON PX →

R3 A P7 → ☀

R4 OFF PX

P1 P9

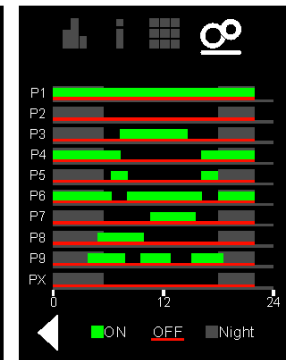

% UV pH Clppm Sens

DOM12

7.35

7.35 pH PS 60 INTEL HYS 2s

FLOW OK pH: 6.5 - 8.5 TANK FUSE pH OK

CAL

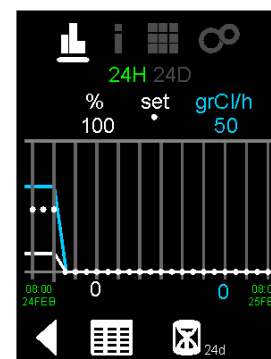

% UV pH Clppm Sens

DOM12

1.25

1.25 Clppm PS OFF INTEL HYS 2m

FLOW OK Clppm: 0.30-3.50

CAL

Astralpool Elite Connect



- standaard voorzien van indicatieve zoutmeting (L-M-H) en temperatuur meting (geïntegreerd in de cel)
- Uitbreidbaar met Plug-in modules voor pH, ORP en vrij chloor (PPM) metingen (5-6-7)
- Voorzien van UV-C lamp besturing (9)
- Tweevoudige communicatie poorten: ethernet (12) en Modbus

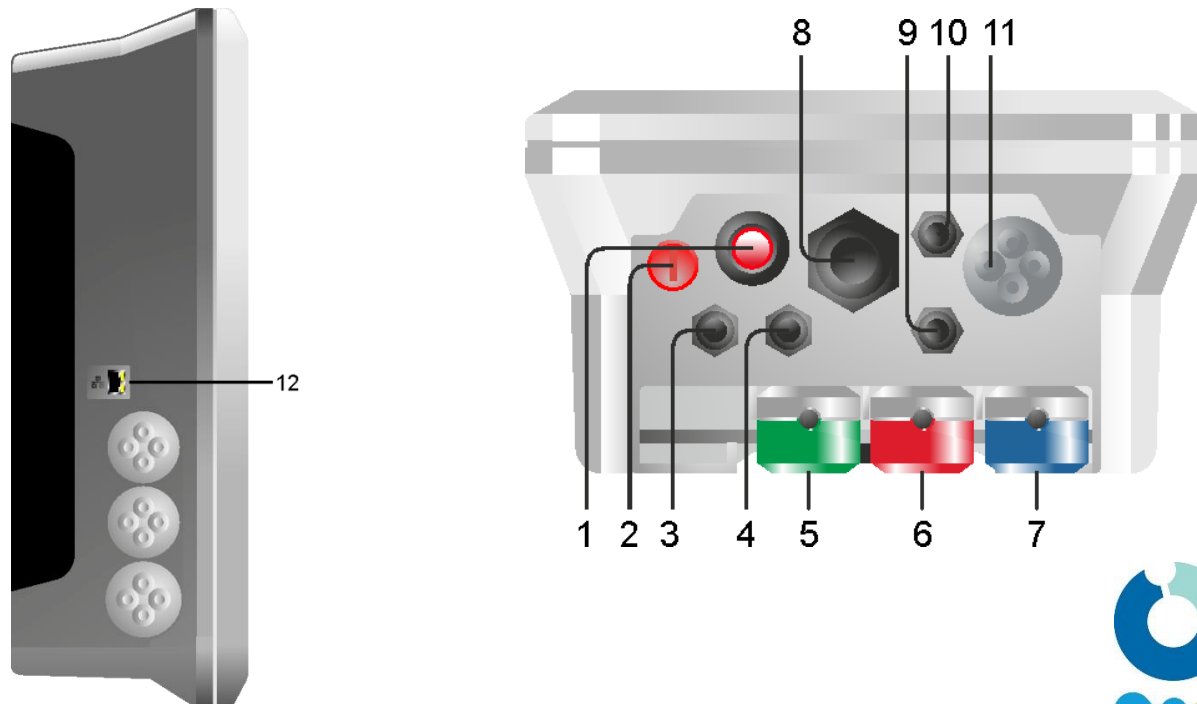

Astralpool Elite Connect



- Geïntegreerde Poolstation functies (Domotica systeem voor bediening via telefoon/tablet/computer)
- Compatibel met Fluidra Connect

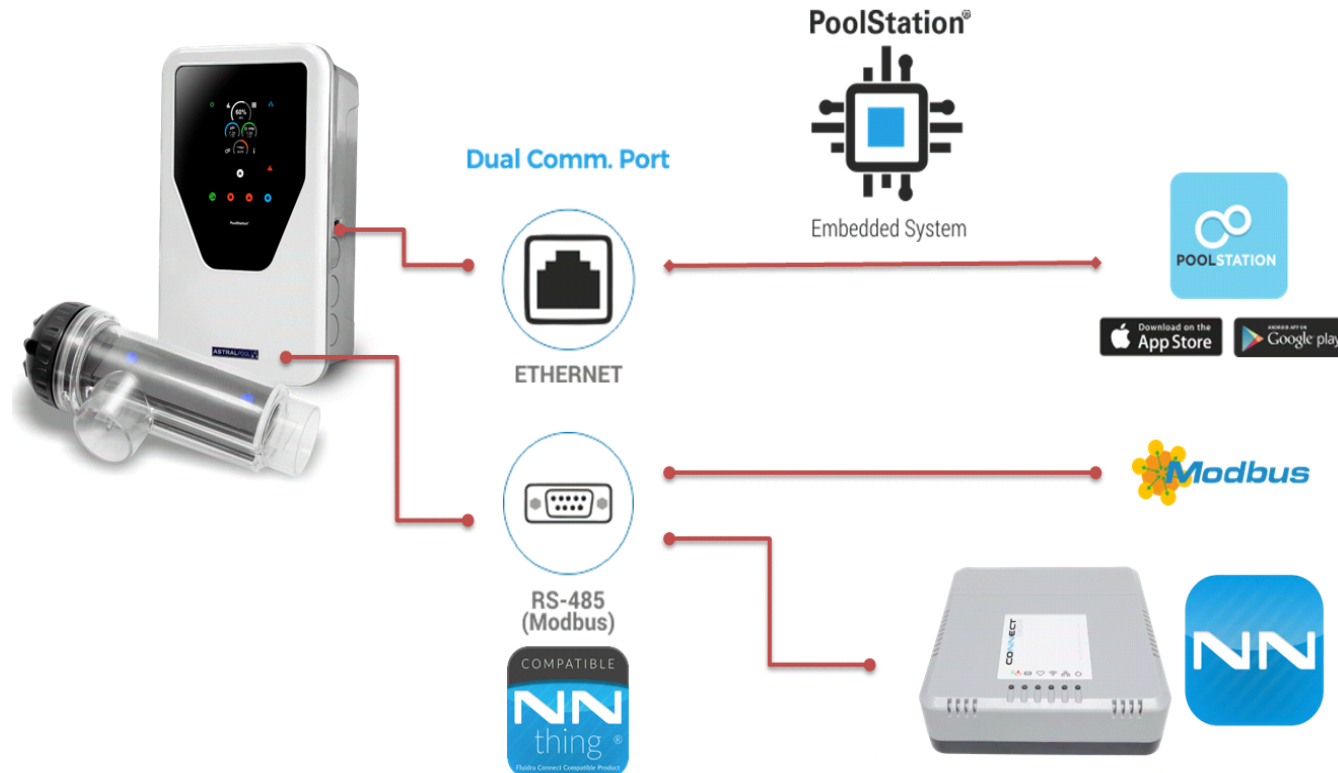

Astralpool Elite Connect



Via PoolStation app

- Gebruikers- en installateursmodule (demo: <https://poolstation.net>)
- Bediening aangesloten apparaten
- Meerdere zwembaden per account

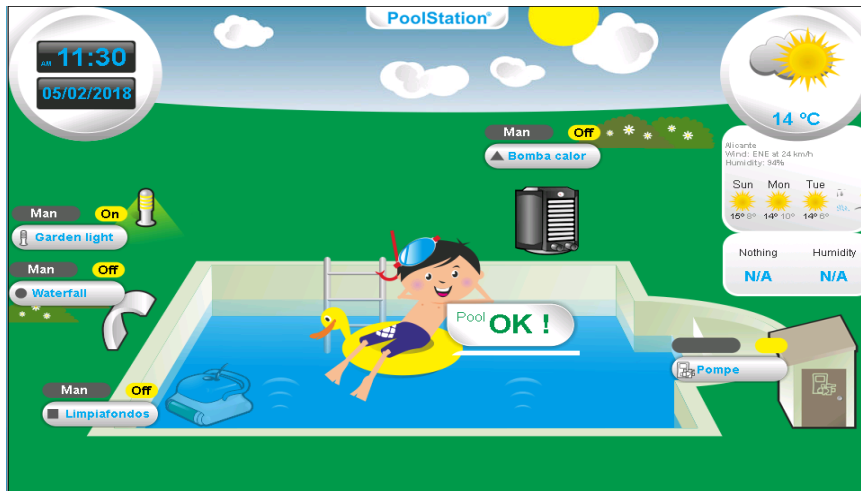

Astralpool Elite Connect

- 4 digitale inputs
- 4 digitale outputs (relais)

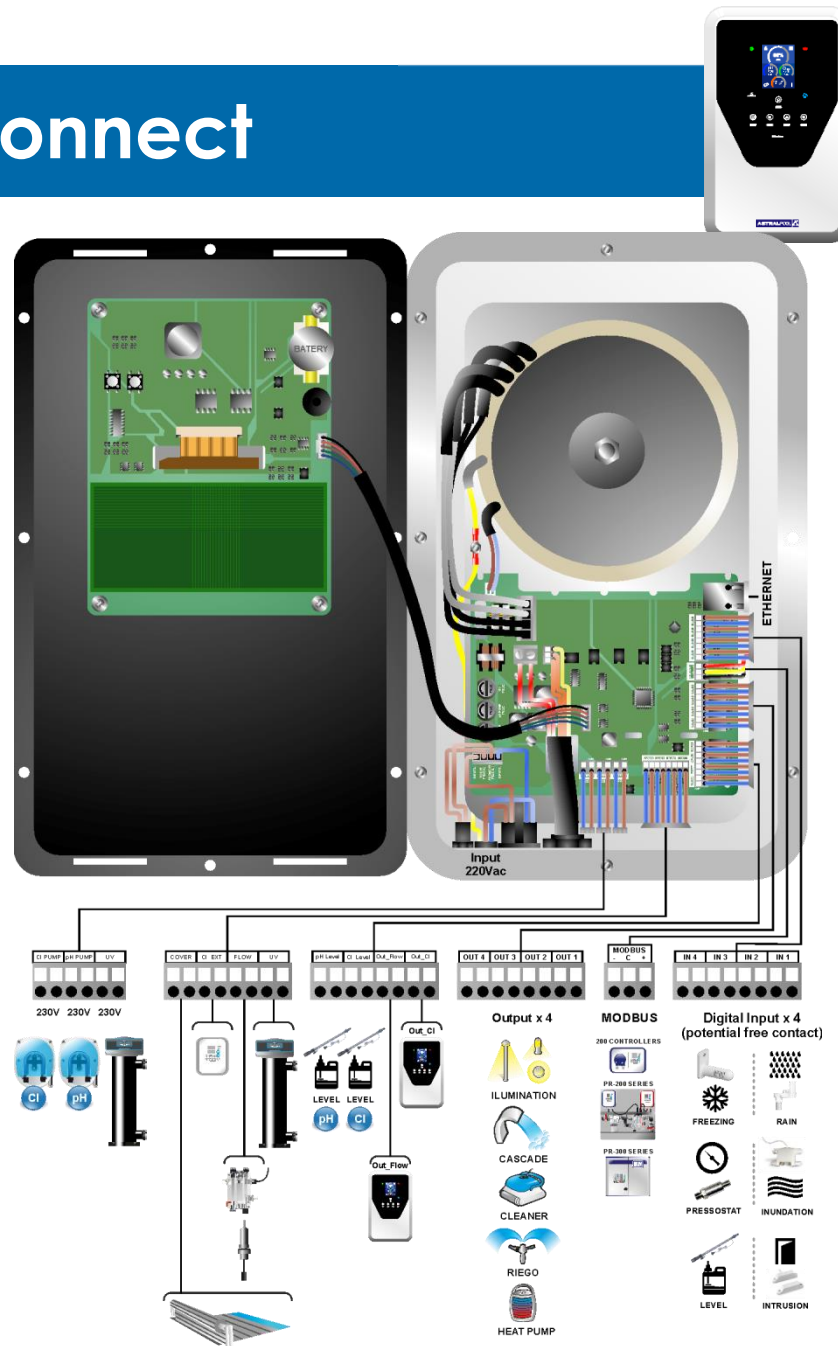

Astralpool Elite Connect

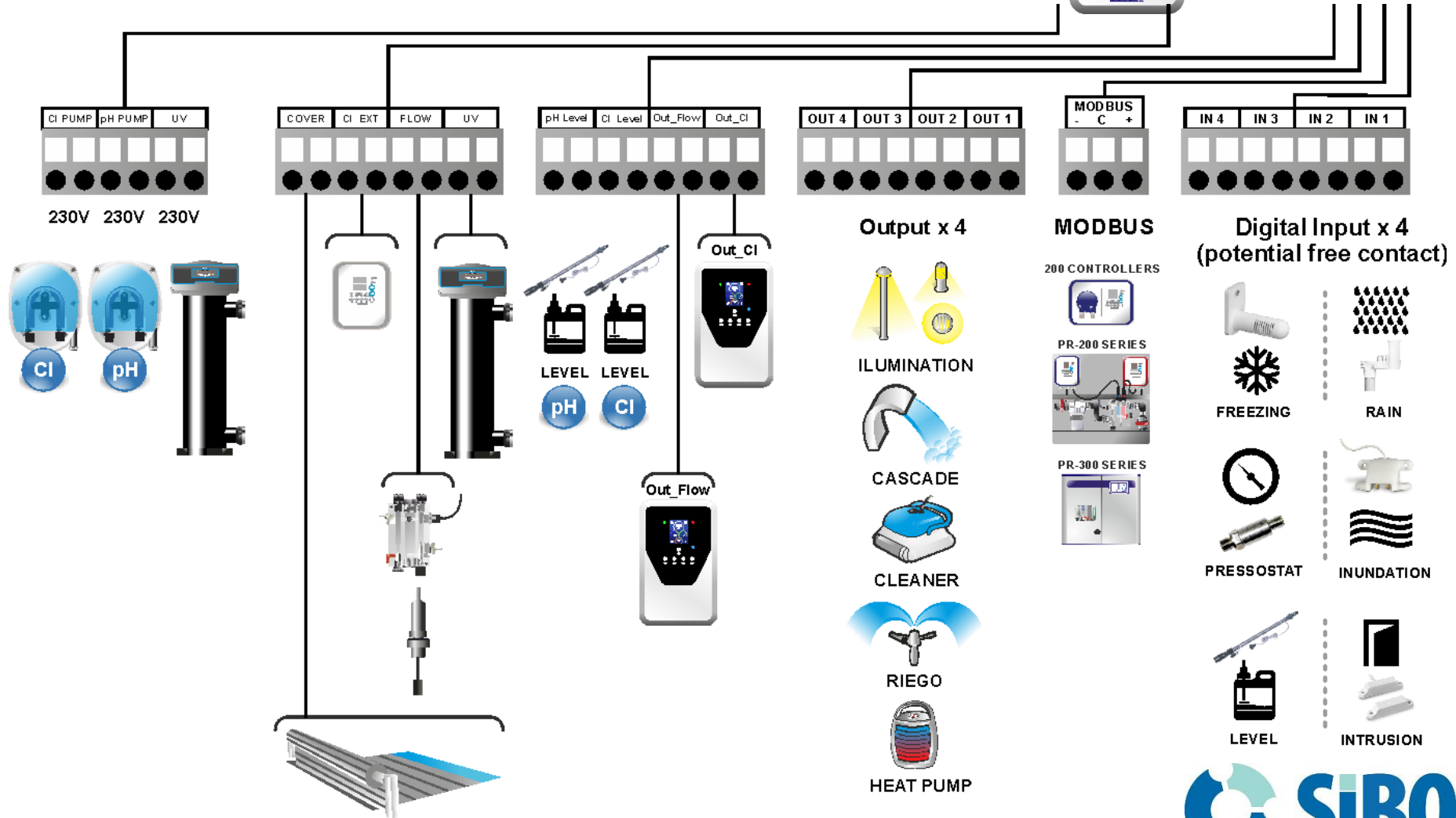

Installatie

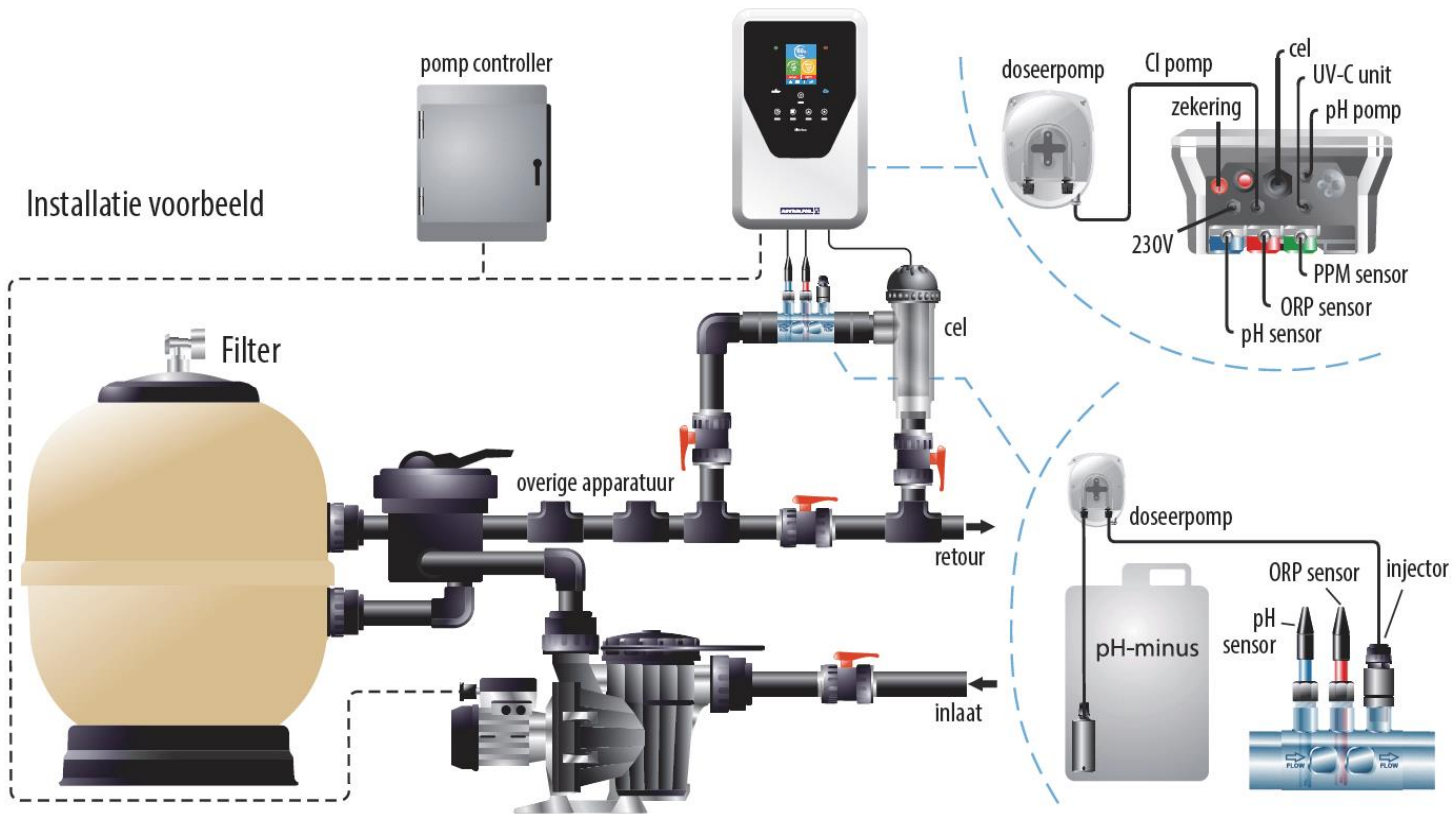



Vragen?

Bedankt voor uw aandacht!